







SLV VW AMAROK PREMIUM FITTING INSTRUCTIONS

KIT NUMBER
10055797

Approx Fit Time: 30 mins

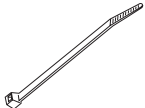
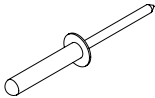
READ INSTRUCTIONS CAREFULLY BEFORE COMMENCING THIS ACTIVITY.

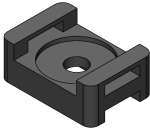
Kit Contents- Hardware

No.	Item Description	Quantity	Image	Service Part Number
1	Central Locking Vehicle Loom	1		10055662
2	Braided Sleeve	1		10055265
3	Reusable Cable Tie	1		10055284
4	Rivet	1		10000089
5	M5 Washer	1		10052603
6	Rivet Cable Tie Mount	1		10055285
7	Cable Tie 610mm	2		10053812

SLV VW AMAROK PREMIUM FITTING INSTRUCTIONS

KIT NUMBER
10055797

Tools Required

Cleaning rags	Drill bit 5mm	
Power drill		
Metric ruler		
Rivet gun		

General Note

- Read through the fitting instructions before installation of accessory.
- Always install the accessory following the fitting instructions. Failure to do so may cause damage to the vehicle or the accessory and void product warranty.
- Ensure all recyclable discarded vehicle/accessory components and packaging are recycled following local recycling regulations.
- It is always recommended that this accessory is fitted by a qualified Technician.
- Safely store and protect any removed vehicle components.
- Ensure all bare metal surfaces are protected using Automotive Bare Metal Primer and touch-up paint.
- Remove all metal swarf and dust from all vehicle surfaces if surface is used for accessory installation.
- Ensure all fasteners are torqued to the specifications as per instruction.
- Apply any adhesives to the vehicle only when the surface temperature is between 20°C to 40°C.

Safety Notes

- Check that all work practises comply with safety standards.
- Appropriate clothing & PPE must be worn.
- While using power tools ensure safe procedures are followed.

SLV VW AMAROK PREMIUM FITTING INSTRUCTIONS

KIT NUMBER
10055797

Step 1

- Feed the SPORTLID V plug through the hole in the front LH corner of the deck.
- Allow approx 200mm to enter the tub.



Step 2

- Run the loom down the gap between the deck and the cab and under the edge of the wheel arch.



Step 3

- Continue to pull the loom up behind the wheel arch liner until it reaches its highest point near the chassis rail.

Note: Image with no vehicle cab shows desired loom position after it is pulled up behind wheel arch liner.



SLV VW AMAROK PREMIUM FITTING INSTRUCTIONS

KIT NUMBER
10055797

Step 4

- Run the loom along the top of the LH chassis rail towards the rear of the vehicle.
- Ensure loom is routed behind the main deck mount, directly inline with the wheel.

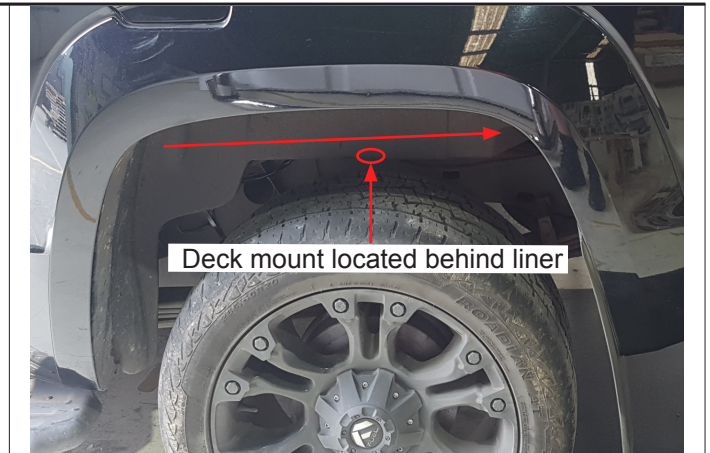

Step 5

- Locate and unplug the fuel filler door central locking module connectors. This is the top plug located on the rear surface of the wheel arch.

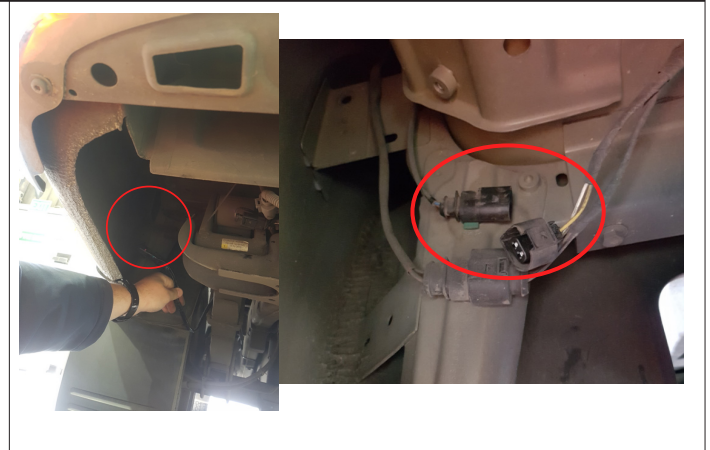

Step 6

- Patch in the corresponding plugs from the central locking loom (item 1)

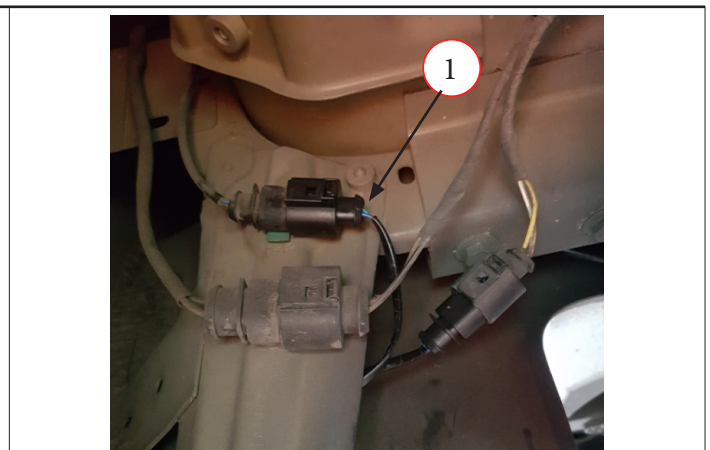

SLV VW AMAROK PREMIUM FITTING INSTRUCTIONS

KIT NUMBER
10055797

Step 7

- Cable tie (item 7) loom to the top of the chassis rail either side of the deck mount (located in step 4).



Step 8

With SPORTLID V on vehicle.

- Slide braided sleeve (item 2) over the exposed vehicle central locking loom and plug into the SPORTLID V loom.

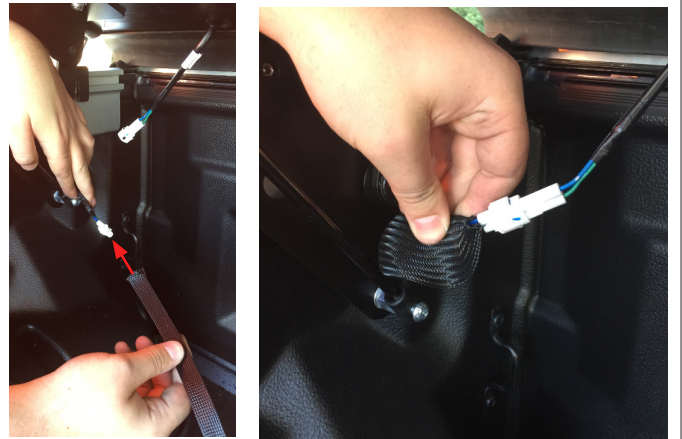

Step 9

- Allow braided sleeve to cover entire length of exposed loom. Secure in place with electrical tape at the highest point if desired.



SLV VW AMAROK PREMIUM FITTING INSTRUCTIONS

KIT NUMBER
10055797

Step 10

- Drill a 5mm hole in the LH Vehicle Connector Rail (VCR) at the location shown.

(15mm up from bottom edge, 20mm in from leading edge).

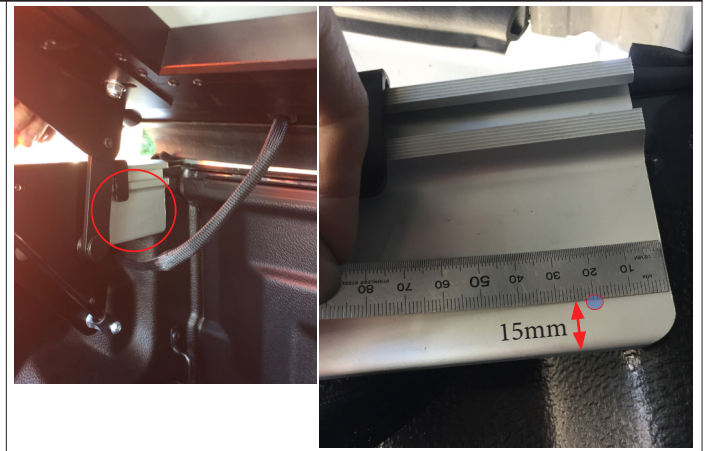

Step 11

- Rivet (item 4) the cable tie mount (item 6) and washer (item 5) to the drilled hole as shown.

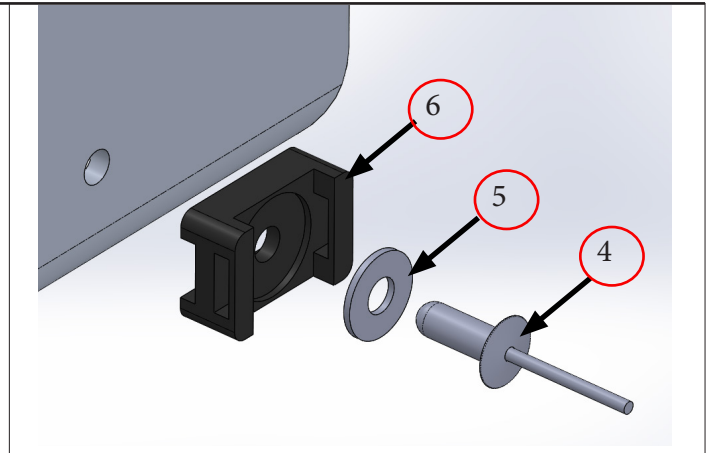

Step 12

- Using the reusable cable tie (item 3) LOOSELY fasten wiring loom to the mount.

Note: The loom must be able to slide through the cable tie as the SPORTLID V is opened and closed.

SPORTLID V Premium
fitment now complete.

